

SOFAS | Serse

MODEL PREFIX 92TK

Structure

Frame made of reinforced fir wood and particleboard panels

Suspension system

With very resistant elastic webbing.

Seat

Firm polyurethane foam with two densities covered with a surface layer of soft foam.

Backrest

Upholstered with polyester fibre, latex and polyurethane foam. Features a manual mechanical adjustment mechanism.

Cover

The fabric cover is always removable.

Leather cover not removable.

Feet

Chromed finish or matt black lacquered metal

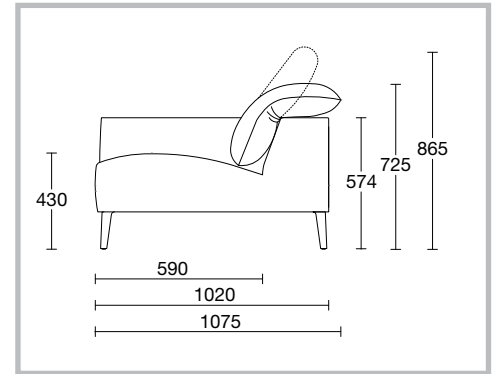

METRES OF SOFA COVERS	METRES FOR 1 ELEMENT in the same finish	
	METRES OF FABRIC	M2 LEATHER
Fabric width 1.40 metres		
SOFA W 2050	12.80	21.90
SOFA W 2350	13.50	23.10
END MODULE W 1820	10.30	17.60
END MODULE W 2120	11.00	18.70
CENTRAL MODULE W 795	5.20	8.80
CENTRAL MODULE W 945	6.00	10.10
CHAISE LONGUE W 1700 D 1025	8.60	14.60
CHAISE LONGUE W 1700 D 1175	9.20	15.70
POUF MODULE 1020x1020	3.90	6.60
CUSHION 420x420	0.60	1.00

A SEAT WITH FIRMER PADDING IS AVAILABLE ON REQUEST AT NO EXTRA CHARGE.

CUSTOM WORKMANSHIP IS AVAILABLE FOR UP TO 15% OF EACH SINGLE MODULE. THIS ENTAILS AN EXTRA CHARGE OF 30% ON TOP OF THE STANDARD PRICE.

The fire-resistant version is available with a 10% surcharge for each single module.

Customer lead times for items in the fire-retardant version require an additional 2 weeks on top of the usual times.

EXAMPLES OF ARRANGEMENTS

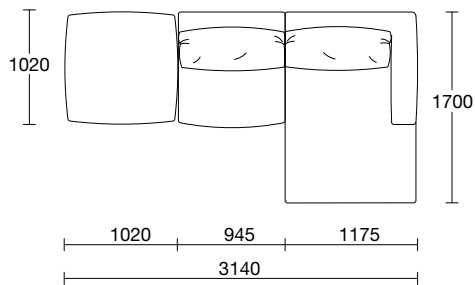
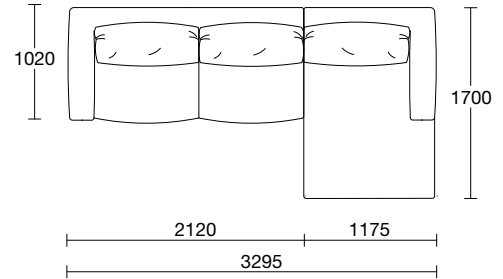
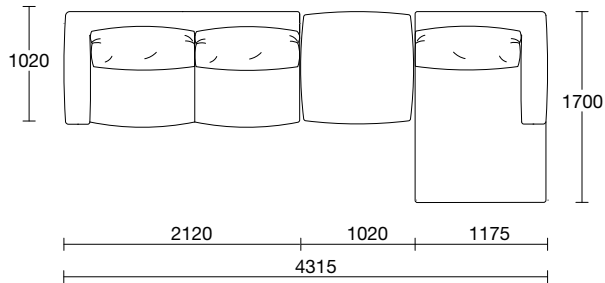
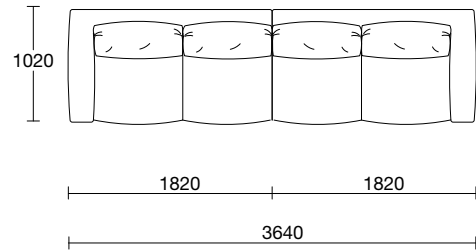
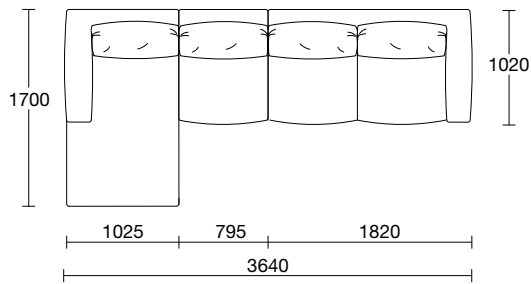
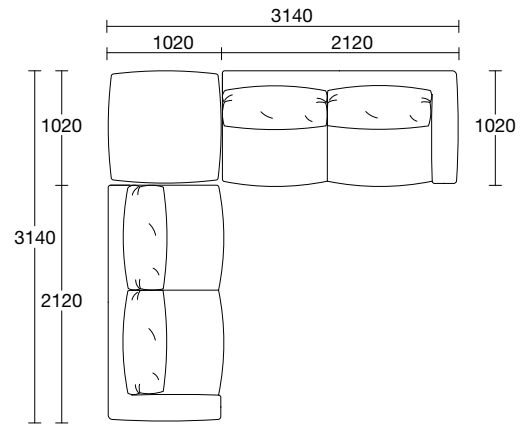
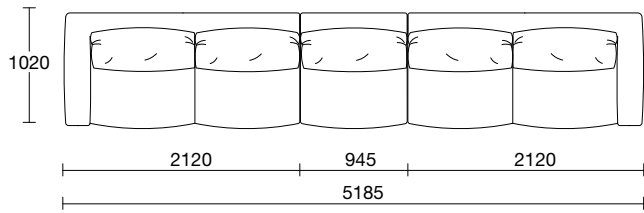

SOFAS | Serse

MODEL PREFIX 92TK

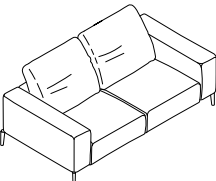
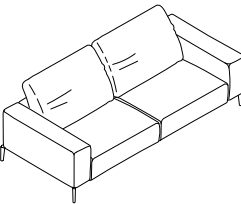
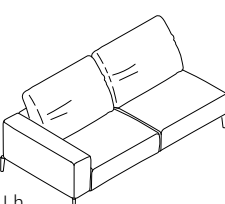

Sofa with a fir structure and particleboard panels. Seat cushions upholstered with double-density foam covered with a layer of soft foam, featuring high-resistance elastic webbing. Backrest upholstered with polyester fibre, latex and polyurethane foam, featuring a manual mechanical adjustment system. Removable fabric cover, non-removable cover in the leather version. Feet are available with a chromed or matt black finish.

	W	H	D	CODE	FABRIC	complete module	CODE	cover only			
	2050	725/865	1020/1075	F3R06	Customer's fabric	2.746	8RF3R06	1.074			
					fabric 1	3.266		1.593			
					fabric 2	3.401		1.729			
					fabric 3	3.605		1.932			
					fabric 4	3.899		2.226			
					leather P1	-		-			
					leather P2	5.458		-			
					leather P3	6.170		-			
					leather P4	-		-			
						2350		725/865	1020/1075	F3R07	Customer's fabric
fabric 1	3.447	1.616									
fabric 2	3.582	1.752									
fabric 3	3.808	1.978									
fabric 4	4.125	2.294									
leather P1	-	-									
leather P2	5.774	-									
leather P3	6.509	-									
leather P4	-	-									
 Lh	1820	725/865	1020/1075	Rh F3R03D			Customer's fabric				2.644
				Lh F3R03S	fabric 1	2.983		Lh 8RF3R03S	1.435		
					fabric 2	3.085			1.537		
					fabric 3	3.254			1.706		
					fabric 4	3.492			1.944		
					leather P1	-			-		
					leather P2	4.757			-		
					leather P3	5.334			-		
					leather P4	-			-		
				 Lh	2120	725/865		1020/1075	Rh F3R04D	Customer's fabric	
Lh F3R04S	fabric 1	3.153	Lh 8RF3R04S				1.503				
	fabric 2	3.266					1.616				
	fabric 3	3.447					1.797				
	fabric 4	3.695					2.045				
	leather P1	-					-				
	leather P2	5.051					-				
	leather P3	5.639					-				
	leather P4	-					-				

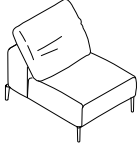
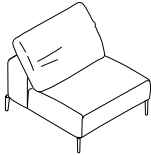
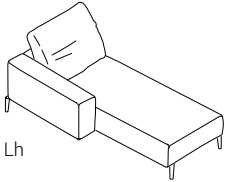
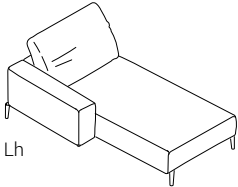
■ Modules without armrests have finished sides.

	W	H	D	CODE	FABRIC	complete module	CODE	cover only
<p>CENTRAL MODULE W 795</p> 	795	725/865	1020/1075	F3RN1	<p>Customer's fabric</p> <p>fabric 1</p> <p>fabric 2</p> <p>fabric 3</p> <p>fabric 4</p> <p>leather P1</p> <p>leather P2</p> <p>leather P3</p> <p>leather P4</p>	<p>1.559</p> <p>1.740</p> <p>1.797</p> <p>1.887</p> <p>1.989</p> <p>-</p> <p>2.644</p> <p>2.927</p> <p>-</p>	8RF3RN1	<p>644</p> <p>825</p> <p>881</p> <p>972</p> <p>1.074</p> <p>-</p> <p>-</p> <p>-</p> <p>-</p>
<p>CENTRAL MODULE W 945</p> 	945	725/865	1020/1075	F3RN2	<p>Customer's fabric</p> <p>fabric 1</p> <p>fabric 2</p> <p>fabric 3</p> <p>fabric 4</p> <p>leather P1</p> <p>leather P2</p> <p>leather P3</p> <p>leather P4</p>	<p>1.684</p> <p>1.898</p> <p>1.955</p> <p>2.057</p> <p>2.181</p> <p>-</p> <p>2.927</p> <p>3.254</p> <p>-</p>	8RF3RN2	<p>667</p> <p>881</p> <p>938</p> <p>1.040</p> <p>1.164</p> <p>-</p> <p>-</p> <p>-</p> <p>-</p>
<p>CHAISE LONGUE W 1700 D 1025</p>  <p>Lh</p>	1700/ 1750	725/865	1025	<p>Rh F3RP1D</p> <p>Lh F3RP1S</p>	<p>Customer's fabric</p> <p>fabric 1</p> <p>fabric 2</p> <p>fabric 3</p> <p>fabric 4</p> <p>leather P1</p> <p>leather P2</p> <p>leather P3</p> <p>leather P4</p>	<p>2.237</p> <p>2.543</p> <p>2.644</p> <p>2.769</p> <p>2.972</p> <p>-</p> <p>4.034</p> <p>4.509</p> <p>-</p>	<p>Rh 8RF3RP1D</p> <p>Lh 8RF3RP1S</p>	<p>780</p> <p>1.085</p> <p>1.187</p> <p>1.311</p> <p>1.514</p> <p>-</p> <p>-</p> <p>-</p> <p>-</p>
<p>CHAISE LONGUE W 1700 D 1175</p>  <p>Lh</p>	1700/ 1750	725/865	1175	<p>Rh F3RP2D</p> <p>Lh F3RP2S</p>	<p>Customer's fabric</p> <p>fabric 1</p> <p>fabric 2</p> <p>fabric 3</p> <p>fabric 4</p> <p>leather P1</p> <p>leather P2</p> <p>leather P3</p> <p>leather P4</p>	<p>2.396</p> <p>2.701</p> <p>2.769</p> <p>2.949</p> <p>3.153</p> <p>-</p> <p>4.283</p> <p>4.791</p> <p>-</p>	<p>Rh 8RF3RP2D</p> <p>Lh 8RF3RP2S</p>	<p>836</p> <p>1.141</p> <p>1.209</p> <p>1.390</p> <p>1.593</p> <p>-</p> <p>-</p> <p>-</p> <p>-</p>

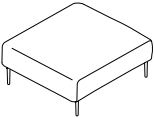
■ Modules without armrests have finished sides.

	W	H	D	CODE	FABRIC	complete module	CODE	cover only
<p>POUF MODULE 1020x1020</p> 	1020	430	1020	F3RF1	Customer's fabric	1.119	8RF3RF1	305
					fabric 1	1.254		429
					fabric 2	1.300		475
					fabric 3	1.356		531
					fabric 4	1.446		622
					leather P1	-		-
					leather P2	1.910		-
					leather P3	2.136		-
					leather P4	-		-
					<p>CUSHION 420x420</p> 	420		420
fabric 1	88	68						
fabric 2	93	72						
fabric 3	104	84						
fabric 4	115	95						
leather P1	-	-						
leather P2	197	-						
leather P3	221	-						
leather P4	-	-						

■ Modules without armrests have finished sides.